

Country of Origin : China
 Operating Temperature : 0~40 [°C]
 Dimension : 63.6 x 29.5 x 45.6 [mm]

Efficiency level (ErP) :



Approvals / Marks :



Features:

Available in version: W2E(EU), W2(USA/Japan/Canada/Taiwan), W3U(UK), W2A (Australia), W2C (China), W2K(Korea).

Wall-mount power supply, single output.

Overload, over voltage & short protection.

Wide range Input (90 ~ 264) VAC / (47 ~ 63) Hz.

For I.T.E. use only + RoHS conform.

Specification:

	Model	Voltage DC [V]	Loading [A]	Total regul. [%]	OCP [A]	OVP [V]	Hold up time [ms]	Efficiency [%]	Max. Power [W]	Ripple & Noise [mV] p-p	Connector [mm]
ErP V.	SYS1381-1005-Wxx	5	0~2.0	±5	2.4~5.0	10±4	8	>73.4	10	80	1.7x4.0x11
	SYS1381-1005-Wxx	5	0~2.0	±5	2.4~5.0	10±4	8	>73.4	10	80	2.1x5.5x11
	SYS1381-0606-Wxx	6	0~1.0	±5	1.3~3.5	10±3	10	>70.0	6	120	2.1x5.5x11
	SYS1381-0808-Wxx	7,5	0~1.07	±5	1.3~3.5	16±7	8	>72.0	8	130	2.1x5.5x11
	SYS1381-0909-Wxx	9	0~1.0	±5	1.5~3.5	15±4	8	>73.0	9	130	2.1x5.5x11
	SYS1381-1212-Wxx	12	0~1.0	±5	1.2~3.5	18±4	8	>77.8	12	180	2.1x5.5x11
Wxx	Possible to order with	Wxx = W2E - Europe W2 - USA,Canada,Japan W3U - UK W2A - Australia W2C - China W2K -Korea									
OEM Production	This model is certified for Output: Uout[V]/Pout[W]max : (5/10, 6/6, 7.5/8, 9/9,12/12). Pout=by 1W steps										
OUTPUT	Turn on delay	3000 ms max									
	Hold up time	Ref. upon table @ AC nominal input@ output full load (1 half cycle)									
	Efficiency (Normal)	>70% @ 240VAC input & Full load									
INPUT	Voltage	(90 ~ 264)VAC									
	Frequency	(47 ~ 63) Hz									
	Current	0.5A rms @ any input voltage and rated DC output rated load									
	Inrush Current (cold start)	40/60Amax. @ 264VAC input. Cold start at 240VAC input, with rated load and 25°C ambient									
	Leakage current	0.25 mA Max.									
	Power consumption	0.3W rms max. At AC nominal input@output min load									
PROTECTION	Over Current	The power supply will be auto recovered when over current faults remove. >>Fold back<<									
	Over Voltage	The power supply will not be auto recovered when faults remove >>Voltage limit<<									
	Short Circuit	The power supply will be auto recovered when short circuit faults remove. An output short circuit is defined as any output impedance of less than 0.1 Ω.									
	Protection class	II.									
OTHERS	Dielectric Strength(Hi-pot)	Primary to Secondary: 3000VAC / 10mA / 60s									
	M.T.B.F	500,000 Calculated Hours at 25°C, by Telcordia SR-332									
	Cable length	2wires. / 2468#22*2C 1370mm (4.5feet) or customer requirements									
	Input protection	1A Fuse, The power supply shall be protected against power line surges and any abnormal condition.									
	Temperature coefficient:	< ±0.5% / °C									
ENVIRONMENT	Temperature	Operating: (0 ~ 40)°C / Storage: (-20 ~ 85)°C									
	Humidity	Operating:8% ~ 90% RH / Storage: 5% ~ 95% RH non condensing									
SAFETY	CE TUV/GS CB FCC cULus BSMI VCCI PSE T-License SAA C-Tick CCC KC S Mark RCM										
CE	EMC	2014/30/EU									
	LVD	2014/35/EU EN 60950-1:2006+A11+A1+A12+A2									
WEIGHT	1pc	N.W.: 90g/pc G.W.: 100g/pc									
PACKING	Box	0.48(L) x 0.44(W) x 0.26(H) [m] 0.435(L) x 0.370(W) x 0.175(H) [m]									
		80pcs / 1box (100pcs – 2011/2012) G.W.: 10 kg/box									

Mechanical case specification:

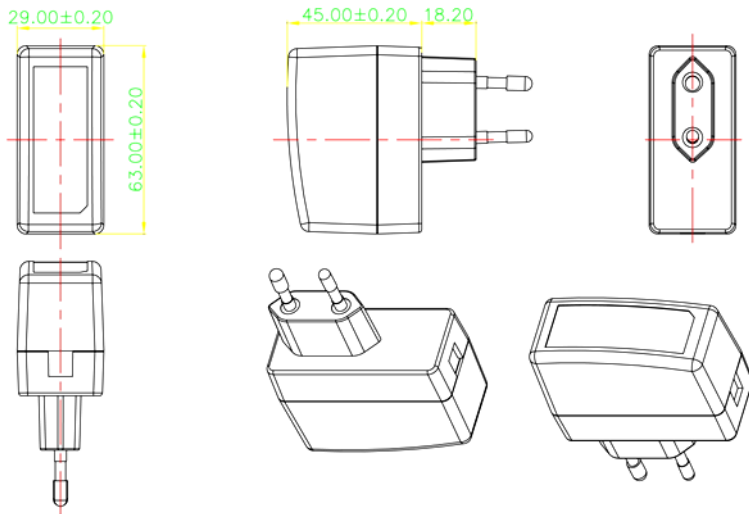

Mechanical specification (country housing):

Europe / Korea type (W2E/W2K)

US / Canada type (W2)

Australia type (W2A)

UK type (W3U)

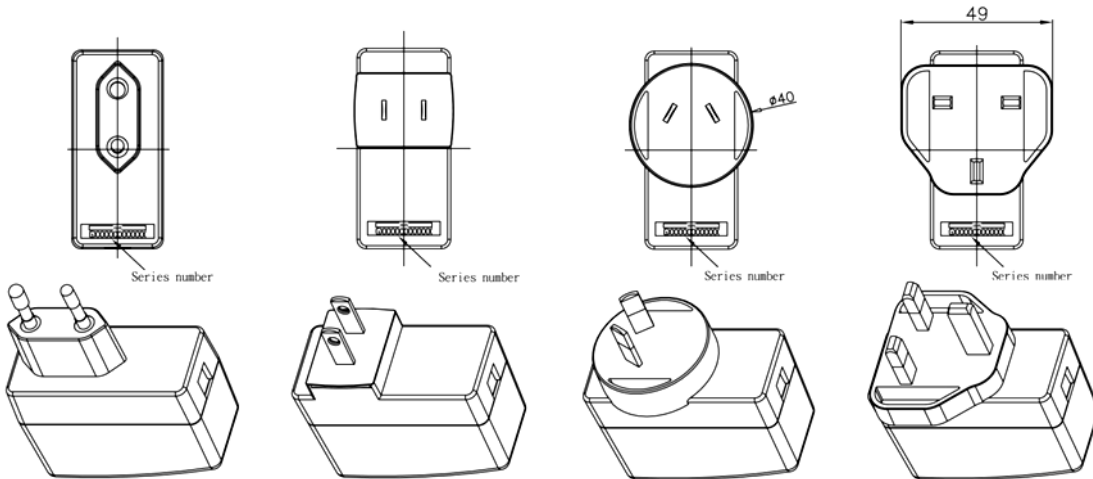

Cable specification:

a) 2.1*5.5*11 (2468#22*2C / 5FT)

