

(XDR-75-xx)



(XDR-75-xxLA)



(XDR-75-xxPI)



IS 13252



(By request Note.6)

(By request)

### Features

- 85~305Vac input (277Vac available)
- Global certificates in multi-fields(ITE 62368-1, Industrial 61558-1/-2-16,61010) & Marine DNV,SEMI47,CID2 HazLoc approved
- 30mm ultra slim width
- High efficiency up to 91% and no load power dissipation 0.7W~1W by R.C.
- 200% peak power capability
- 600% transient peak current capability
- Built-in constant current limiting circuit
- Protections: Short circuit / Overload / Over voltage / Over temperature
- Fanless design, cooling by free air convection
- Over voltage category III (OVC III)
- -40~+85°C wide range operation temperature(>+60°C derating)
- Operating altitude up to 5000 meters
- Built-in remote ON/OFF control and DC OK relay contact
- Ultra low inrush current <6~15A
- Tool free terminal block (LA Type)
- Conformal coating
- Can be installed on DIN rail TS-35/75 or15
- 5 years warranty

### Description

The XDR-75 series is a 75W AC/DC high-end ultra slim industrial DIN rail power. Key features of this series include a narrow 30mm casing, optimizing system installation space, and an ultra-wide input range of 85~305Vac suitable for global use. It boasts a maximum efficiency of 91% and a low standby power consumption 0.7W~1W for energy savings and carbon reduction. It provides constant current with up to 200% peak power, and can handle instantaneous peak current of 600%. It has a fanless design, ultra-wide operating temperature range of -40 to +85°C (up to +60°C at full load); OVCIII compliance; ultra-low inrush current of <6~15A, and includes DC OK and remote ON/OFF functions. The internal PCB has a coating for basic moisture and dust protection, and it has multiple terminal blocks for selection. With comprehensive protection functions, complete safety certifications, and a 5-years warranty, the XDR-75 series is a compact, high-performance, and highly reliable DIN rail power supply.

### Model Encoding

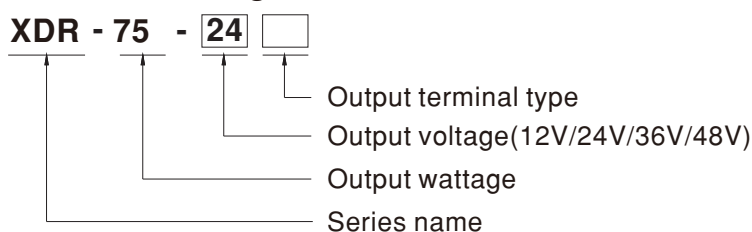



### Applications

- Industrial control system
- Semiconductor fabrication equipment
- Factory automation
- Electro-mechanical apparatus

### GTIN CODE

MW Search: <https://www.meanwell.com/serviceGTIN.aspx>

Terminal Type Options		Note
Blank	Screw Terminal 	In stock
LA	Lever Actuated 	In stock
PI	Push In 	In stock

SPECIFICATION		XDR-75-12□	XDR-75-24□	XDR-75-36□	XDR-75-48□
		□ =Blank, LA, PI			
<b>OUTPUT</b>					
DC VOLTAGE		12V	24V	36V	48V
LOAD CURRENT RANGE		0 ~ 6.24A	0 ~ 3.12A	0 ~ 2.08A	0 ~ 1.56A
RATED POWER		74.88W	74.88W	74.88W	74.88W
PEAK	CURRENT (5sec.)	12.5A	6.25A	4.17A	3.13A
	POWER (5sec.)	150W			
RIPPLE & NOISE (max.)	Note.2	100mVp-p	100mVp-p	120mVp-p	120mVp-p
VOLTAGE ADJ. RANGE		12 ~ 15V	24 ~ 29V	36 ~ 42V	48 ~ 56V
VOLTAGE TOLERANCE		Note.3 ±1.0%	±1.0%	±1.0%	±1.0%
LINE REGULATION		±0.5%	±0.5%	±0.5%	±0.5%
LOAD REGULATION		±1.0%	±1.0%	±1.0%	±1.0%
SETUP, RISE TIME		1200ms, 60ms/230Vac    2500ms, 60ms/115Vac at full load			
HOLD UP TIME (Typ.)		16ms/230Vac    10ms/115Vac at full load			
<b>INPUT</b>					
AC VOLTAGE RANGE		85 ~ 305Vac			
DC VOLTAGE RANGE		80 ~ 431Vdc (Derating 50% Load @80Vdc)			
NO LOAD CONSUMPTION(Typ.)	Remote Power OFF	0.7W @115Vac & 230Vac	1W @115Vac & 230Vac		
	Remote Power ON	1.5W @115Vac & 230Vac			
FREQUENCY RANGE		47 ~ 63Hz			
EFFICIENCY (Typ.)		89%	90%	91%	91%
AC CURRENT (Typ.)		1.5A/115Vac    0.9A/230Vac    0.8A/277Vac			
INRUSH CURRENT (Typ.)		COLD START    6A/115Vac    10A/230Vac    15A/277Vac			
LEAKAGE CURRENT		<1mA / 240Vac    <1.5mA / 277Vac			
<b>PROTECTION</b>					
OVERLOAD		105%~200% rated output power for more than 5 sec then constant current limiting at rate current without shutdown when Vo=10%~100%; Constant current limiting or Latch mode when Vo<10% rated voltage.			
OVER VOLTAGE		16 ~ 19V	30 ~ 34V	43 ~ 50V	57 ~ 66V
		Protection type : Shut down o/p voltage , re-power on to recover			
OVER TEMPERATURE		Protection type : Shut down o/p voltage, recovers automatically after temperature goes down			
<b>FUNCTION</b>					
DC OK RELAY CONTACT		Relay Contact Ratings (max.):30Vdc/1A, 30Vac/0.5A resistive load			
REMOTE CONTROL		Power ON :RC + ~ RC- keep<0.5Vdc or open			
		Power OFF:RC + ~ RC- keep 4~5Vdc by external voltage			
TRANSIENT PEAK CURRENT CAPABILITY		12V: 500% rated current for 4ms;    24V/36V/48V: 600% rated current for 4ms			
<b>ENVIRONMENT</b>					
WORKING TEMP.		-40 ~ +85°C (Refer to "Derating Curve")			
WORKING HUMIDITY		20 ~ 95% RH non-condensing			
STORAGE TEMP., HUMIDITY		-40 ~ +85°C, 10 ~ 95% RH non-condensing			
TEMP. COEFFICIENT		±0.03%/°C (0 ~ 60°C) on Load output			
VIBRATION		Component:10 ~ 500Hz, 2G 10min./1cycle, 60min. each along X, Y, Z axes; Mounting: Compliance to IEC60068-2-6			

SPECIFICATION	XDR-75-12 <input type="checkbox"/>	XDR-75-24 <input type="checkbox"/>	XDR-75-36 <input type="checkbox"/>	XDR-75-48 <input type="checkbox"/>
	<input type="checkbox"/> =Blank, LA, PI			
<b>SAFETY &amp; EMC</b> <span style="float:right">Note.4&amp;5&amp;6</span>				
<b>SAFETY STANDARDS</b>	CB IEC62368-1, IEC61558-1/2-16, IEC61010-1/2-201 TUV BS EN/EN62368-1, BS EN/EN61558-1/2-16, BS EN/EN61010-1/2-201 UL UL 121201/CSA C22.2 NO.213.17 Class I, DIV2 Group A,B,C,D Hazardous Locations T4; UL61010-1/2-201 CCC GB4943.1 BSMI CNS15598-1 EAC TPTC004 Marine DNV SEMI F47 approved KC/BIS <b>KC62368-1 and BIS IS 13252 (Part 1) certified, no stock by request ,contact sales for inquires</b>			
<b>OVER VOLTAGE CATEGORY</b> <span style="float:right">Note.7</span>	IEC/EN 61558-1/2-16 (OVC III, altitude up to 2000m ) IEC/EN/UL 61010-1/2-201 (OVC II, altitude up to 5000m ) IEC/EN 62368-1 (OVC II, altitude up to 5000m )			
<b>SAFETY EXTRA-LOW VOLTAGE(SELV)</b>	IEC/EN 61558-2-16 (SELV) IEC/EN 62368-1 (SELV / ES1 )			
<b>WITHSTAND VOLTAGE</b>	I/P-O/P: 4KVac I/P-FG: 2KVac O/P-FG: 1.5KVac O/P-DC OK: 0.5KVac			
<b>ISOLATION RESISTANCE</b>	I/P-O/P, I/P-FG, O/P-FG: 100M Ohms/500VDC/25°C/ 70%RH			
<b>EMC EMISSION</b>	<b>Parameter</b>	<b>Standard</b>	<b>Test Level / Note</b>	
	Conducted	BS EN/EN55032 (CISPR32) / BS EN/EN61204-3 / CNS15936 / KS C 9832	Class B	
	Radiated	BS EN/EN55032 (CISPR32) / BS EN/EN61204-3 / CNS15936 / KS C 9832	Class B	
	Harmonic Current	BS EN/EN61000-3-2	Class A	
	Voltage Flicker	BS EN/EN61000-3-3	-----	
<b>EMC IMMUNITY</b>	BS EN/EN55035 , BS EN/EN61204-3, BS EN/EN61000-6-2(BS EN/EN50082-2) ,KS C 9835, SEMI F47 tested at 200Vac			
	<b>Parameter</b>	<b>Standard</b>	<b>Test Level / Note</b>	
	ESD	BS EN/EN61000-4-2	Level 4, 15KV air ; Level 4, 8KV contact; criteria A	
	Radiated	BS EN/EN61000-4-3	Level 3, 10V/m ; criteria A	
	EFT / Burst	BS EN/EN61000-4-4	Level 4, 4KV ; criteria A	
	Surge	BS EN/EN61000-4-5	Level 4, 2KV/Line-Line ;Level 4, 4KV/Line-Line-Chassis ;criteria A	
	Conducted	BS EN/EN61000-4-6	Level 3, 10V ; criteria A	
	Magnetic Field	BS EN/EN61000-4-8	Level 4, 30A/m ; criteria A	
<b>OTHERS</b>				
<b>MTBF</b>	1907.3K hrs min. Telcordia SR-332 (Bellcore); 333.9K hrs min. MIL-HDBK-217F (25°C)			
<b>DIMENSION</b>	<b>30*125.2*116mm (W*H*D)</b>			
<b>PACKING</b>	496g; 24pcs/12.9Kg/1.27CUFT			
<b>NOTE</b>				
1. All parameters NOT specially mentioned are measured at 230Vac input, rated load and 25°C of ambient temperature. 2. Ripple & noise are measured at 20MHz of bandwidth by using a 12" twisted pair-wire terminated with a 0.1 μ F & 47 μ F parallel capacitor. 3. Tolerance : includes set up tolerance, line regulation and load regulation. 4. The power supply is considered a component which will be installed into a final equipment. The final equipment must be re-confirmed that it still meets EMC directives. (as available on <a href="https://www.meanwell.com/Upload/PDF/EMI_statement_en.pdf">https://www.meanwell.com/Upload/PDF/EMI_statement_en.pdf</a> ) 5. The Regulatory Compliance Mark (RCM) is applied on a voluntary basis. The equipment meets the relevant IEC or AS/NZS standards, or AS/NZS 3820 where applicable. The use of the RCM mark complies with AS/NZS 4417.1. 6. Some factory or model may not have the BIS logo, please contact your MEAN WELL sales for more information. 7. The ambient temperature derating of 3.5°C/1000m with fanless models and of 5°C/1000m with fan models for operating altitude higher than 2000m(6500ft). 8. Installation clearances : 40mm on top, 20mm on the bottom, 5mm on the left and right side are recommended when loaded permanently with full power. In case the adjacent device is a heat source, 15mm clearance is recommended. ※ Product Liability Disclaimer : For detailed information, please refer to <a href="https://www.meanwell.com/serviceDisclaimer.aspx">https://www.meanwell.com/serviceDisclaimer.aspx</a>				

### Block Diagram

PWM fosc : 65KHz

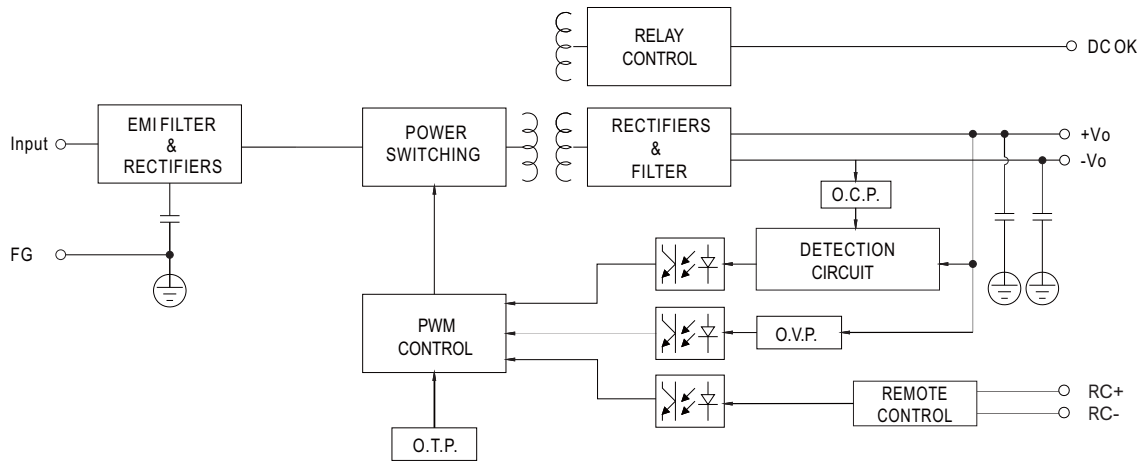

### Derating Curve

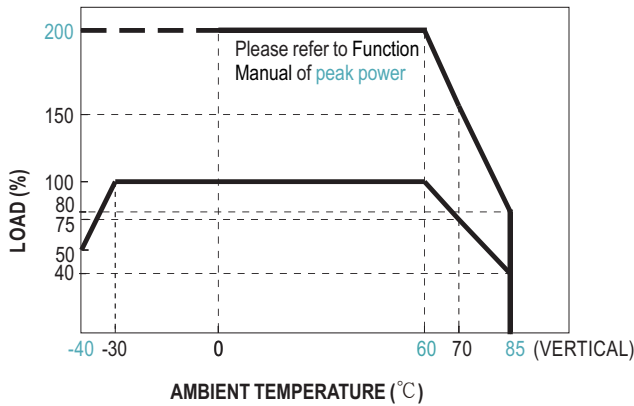

### Output derating VS input voltage

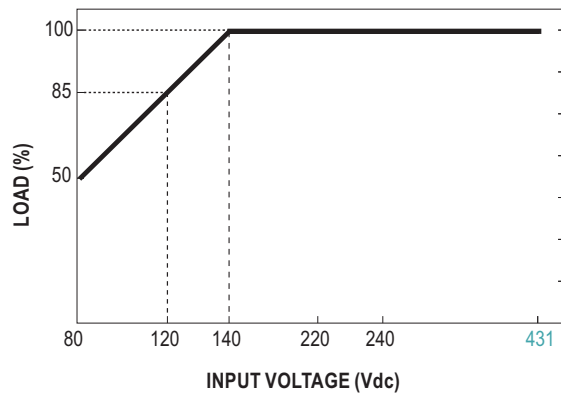
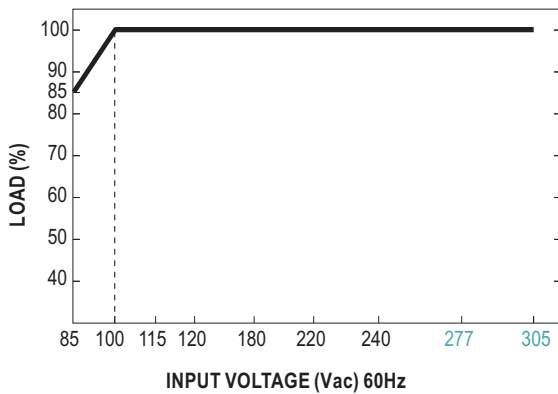

**Peak Power**

$$P_{av} = \frac{P_{pk} \times t + P_{npk} \times (T-t)}{T} \leq P_{rated}$$

$$Duty = \frac{t}{T} \times 100\% \leq 35\%$$

$$t \leq 5 \text{ sec}$$

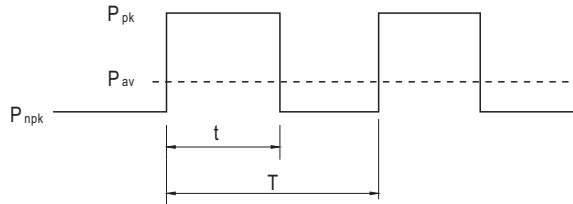

$P_{av}$  : Average output power (W)

$P_{pk}$  : Peak output power (W)

$P_{npk}$  : Non-peak output power(W)

$P_{rated}$  : Rated output power(W)

$t$  : Peak power width(sec)

$T$  : Period(sec)

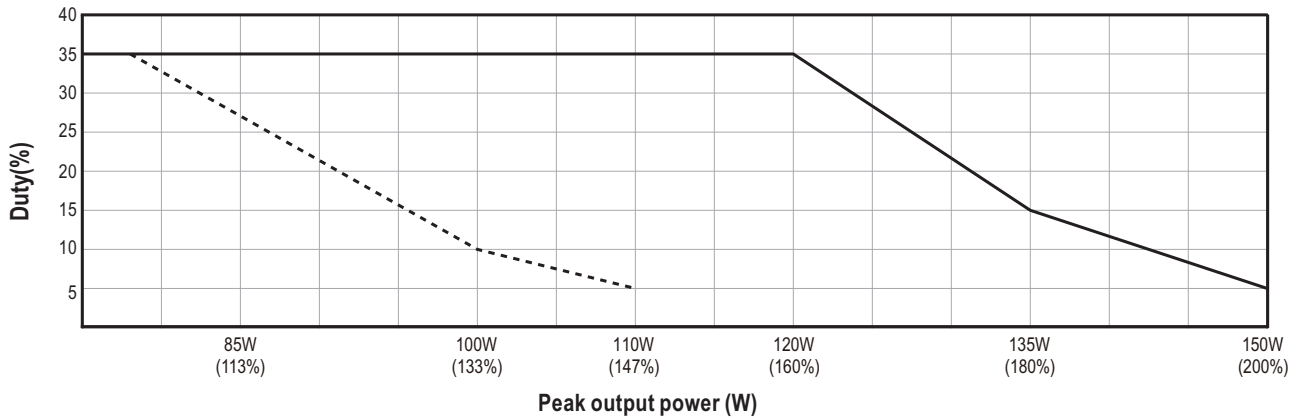

**For example (24V model) :**

$V_{in} = 200Vac$      $Duty_{max} = 5\%$

$P_{av} = P_{rated} = 75W$

$P_{pk} = 150W$

$t \leq 5 \text{ sec}$

$$T \geq \frac{5 \text{ sec}}{5\%} \geq 100 \text{ sec}$$

$$P_{npk} \leq \frac{T P_{av} - t P_{pk}}{T-t}$$

$$P_{npk} \leq 71W$$

**Transient peak current Capability**

The device can deliver peak currents over 2xIo capacity, sustained for several milliseconds.

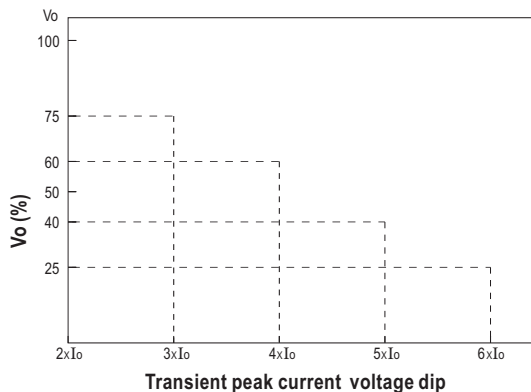

Load	Vo(%)	12V	24V/36V/48V
		Time	Time
3xIo	75	6ms	8ms
4xIo	60	3ms	6ms
5xIo	40	2ms	5ms
6xIo	25	--	4ms

Note: The time indicated in the table refers to Power on AC for more than 3 seconds before applying load.

■ **Function Manual**

Pin No.	Function	Description
1,2	DC OK Relay Contact	Contact close : PSU turns ON/DC_OK ; Contact open : PSU turns OFF/DC_fail; Contact ratings (max.): 30Vdc/1A ,30Vac/0.5A resistive load.
3	RC+	Turns the output ON and OFF by electrical signal Remote power ON : keep<0.5Vdc Remote power OFF: keep 4~5Vdc
4	RC-	

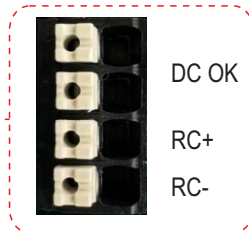
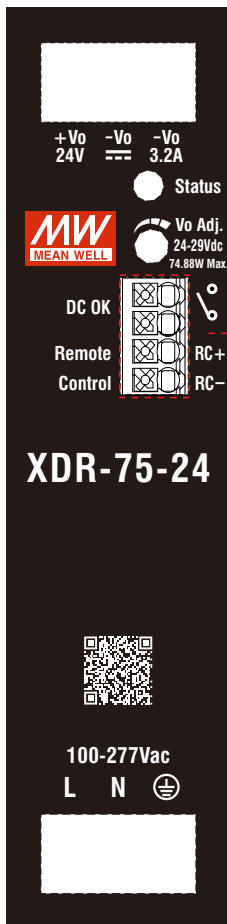

### 1. DC OK Relay Contact

Contact Close	PSU turns ON / DC OK.
Contact Open	PSU turns OFF / DC Fail.
Contact Ratings (max.)	30Vdc/1A, 30Vac/0.5A resistive load.

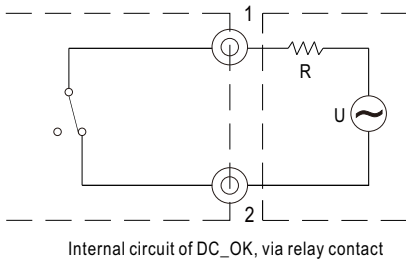
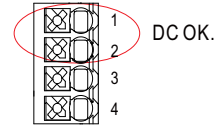

External voltage source (U) and resistor (R)  
(The max. Sink is 30Vdc/1A, 30Vac/0.5A)

### 2. Remote ON/OFF Control

The PSU can be turned ON/OFF by using the "Remote Control" function.

PSU Vo Status	Between RC+(Pin3) and RC-(Pin 4)
Remote power ON	Keep <math>0.5V_{dc}</math> or open
Remote power OFF	Keep 4~5Vdc by external voltage

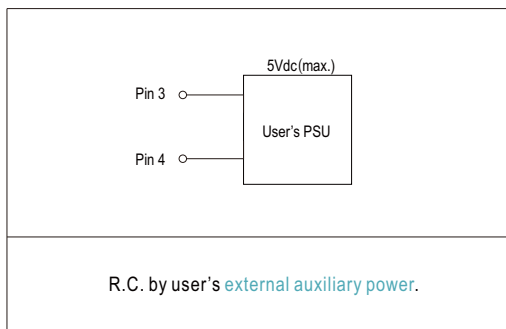
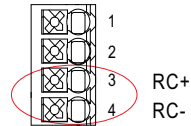

**Mechanical Specification**

(Unit:mm , Tolerance  $\pm 1$ mm)

Case No.301

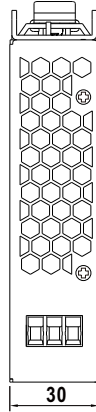

**(A) : Terminal Pin No.Assignment**

Pin No.	Assignment
1	DC Output +Vo
2,3	DC Output -Vo

**(B) : Control Pin No.Assignment**

Pin No.	Assignment
1,2	DC OK Relay Contact
3	RC+
4	RC-

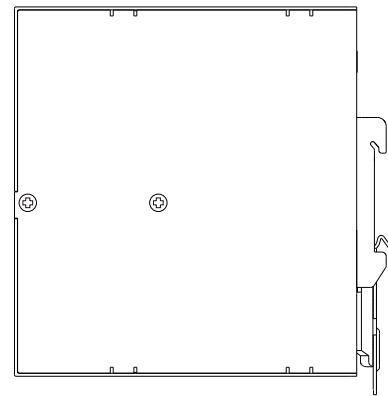
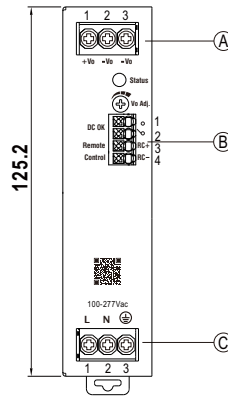
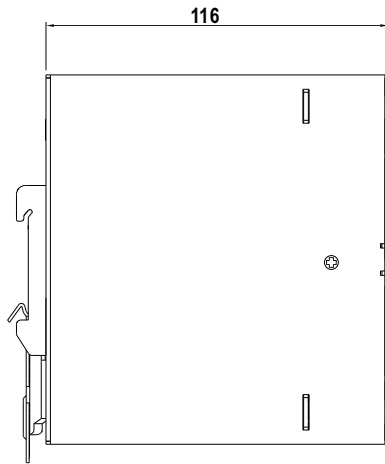

**(C) : Terminal Pin No.Assignment**

Pin No.	Assignment
1	AC/L or DC Input +Vin
2	AC/N or DC Input -Vin
3	FG $\oplus$

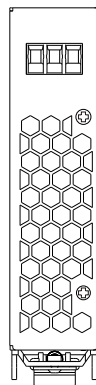

■ **Recommend Wiring**

		AC Input T.B	DC Output T.B	Signal connector
Solid Wire		6mm <sup>2</sup> max.	6mm <sup>2</sup> max.	1.5mm <sup>2</sup> max.
A.W.G		16~10 AWG	16~10 AWG	24~16 AWG
Wire Stripping Length	Blank	10~11mm	10~11mm	8~9mm
	LA	11~12mm	11~12mm	
	PI	14~15mm	14~15mm	
Screw Terminal Torque	Blank	5 Lb-In	5 Lb-In	/
	LA/PI	Not applicable		

■ **Installation Instruction**

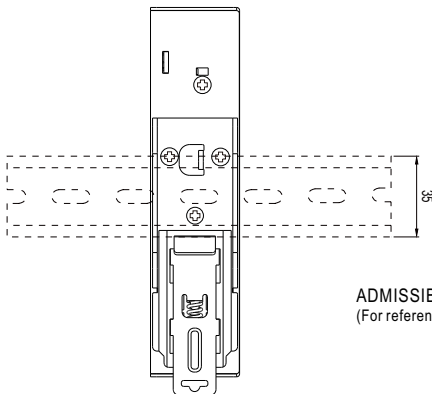

This series fits DIN rail TS35/7.5 or TS35/15.  
For installation details, please refer to the Instruction manual.

ADMISSIBLE DIN-RAIL: TS35/7.5 OR TS35/15  
(For reference only. Not included with unit.)

■ **Installation Manual**

Please refer to : <http://www.meanwell.com/manual.html>